

echOpen

FACTORY

echOpen O1, handheld ultrasound imaging device &
echOpen ON, dedicated software application

User Manual / Instructions for use



Manufacturer's Contact Information

echOpen Factory
Hôpital Hôtel-Dieu
1 Place du Parvis Notre-Dame
75004 Paris – France

Requests for information, assistance, maintenance, and service: support@echopen.com

Website: www.echopen.com

Link e-IFU: <https://www.echopen.com/instructions-for-use>

Copyright

Copyright © echOpen Factory. All rights reserved.

Exclusive Information

This document contains exclusive information which is protected by copyright.

Recognition of Trademarks

The product names mentioned in this manual may be trademarks of their respective licenses.

Disclaimer

The information contained in this manual may be changed without notice.

Some of the features described in this manual may not be available to all Users, based on local regulations and subscribed services.

The names and data used for the examples in this manual are fictitious.

Important Information for the User

Any serious incident(s) related to the echOpen O1 device **must** be notified to the Manufacturer and the Competent Authority of the Member State in which the User and / or patient is based.

Please contact: support@echopen.com

Security Conventions



Warning: Warnings highlight vital information that could jeopardize the safety of the patient, operator, and anyone else in the vicinity.



Caution: Cautions highlight practices that could result in minor injury, device degradation, and / or data loss.

Release Date and Version

2025-04-15 version 12.1

Table of Content

| | |
|---|----|
| echOpen O1, handheld ultrasound imaging device & | 1 |
| echOpen ON, dedicated software application..... | 1 |
| User Manual / Instructions for use..... | 1 |
| Manufacturer's Contact Information | 2 |
| Copyright..... | 2 |
| Exclusive Information | 2 |
| Recognition of Trademarks | 2 |
| Disclaimer..... | 2 |
| Important Information for the User | 2 |
| Security Conventions..... | 2 |
| Release Date and Version..... | 2 |
| Table of Content..... | 3 |
| 1. About echOpen O1..... | 6 |
| 1.1. Overview | 6 |
| 1.2. Intended Purpose | 6 |
| 1.3 Intended use environment..... | 6 |
| 1.4 Target patient population | 6 |
| 1.5. Indications | 7 |
| 1.6. Contraindications | 8 |
| 1.7. Training..... | 8 |
| 1.8. Benefits and Risks of the Device..... | 8 |
| Benefits | 8 |
| Risks | 8 |
| Essential Performance | 8 |
| 2. Safety Guidelines | 9 |
| 2.1. Introduction | 9 |
| 2.2. Basic safety of the echOpen O1 device and its accessories..... | 9 |
| 2.3. Use environment safety | 11 |
| 2.4. Electrical safety | 11 |
| 2.5. Security in case of defibrillation | 12 |
| 2.6. Equipment protection | 12 |
| 2.7. Biological safety..... | 13 |
| 2.8. Operator safety | 13 |
| 2.9. Patient data protection | 14 |
| 3. Introducing the echOpen O1 device and accessories..... | 14 |
| 3.1. Components..... | 14 |
| 3.1.1 Probe..... | 14 |
| 3.1.2 Applied parts | 15 |
| 3.1.3 Mobile device..... | 15 |
| 3.1.4 echOpen ON application | 16 |
| 3.1.5 Probe battery charger | 16 |
| 3.2. Internet connectivity | 17 |

| | |
|---|----|
| 4. Start and set up of the echOpen O1 device..... | 18 |
| 4.1. Charging the probe..... | 18 |
| 4.2. Checking the probe's battery level..... | 18 |
| 4.3. Creating an echOpen account..... | 19 |
| 4.4. echOpen ON app download and installation..... | 20 |
| 4.5. First connection..... | 20 |
| 4.6. Changing the PIN - My Account..... | 21 |
| 4.7. Manage My Probes | 21 |
| Delete a probe from the list..... | 21 |
| Manual pairing | 21 |
| 4.8. Changing the language..... | 21 |
| 4.9. Disconnect from echOpen ON application..... | 22 |
| 4.10. Managing updates to the echOpen ON app..... | 22 |
| 5. Use of the echOpen O1 device | 22 |
| 5.1. Precautions before use..... | 22 |
| 5.2. New consultation | 22 |
| 5.3. Settings..... | 23 |
| Presets..... | 23 |
| Gain..... | 24 |
| Smoothing..... | 25 |
| 5.4. Creating images and video loops..... | 25 |
| Images..... | 25 |
| Video loops | 26 |
| 5.5 End the consultation | 26 |
| 5.6 Adding information | 27 |
| 5.7. View my consultations | 27 |
| Gallery..... | 27 |
| echOpen platform..... | 28 |
| 6. Maintenance of the echOpen O1 device..... | 28 |
| 6.1. Cleaning and disinfection | 28 |
| Cleaning and Disinfection of the echOpen O1 probe..... | 29 |
| Cleaning of the probe | 29 |
| Intermediate Level Disinfection | 29 |
| 6.2. Device Storage..... | 29 |
| 7. Recycling and disposal..... | 30 |
| 8. Troubleshooting | 31 |
| 9. echOpen support..... | 35 |
| 10. Technical features of the echOpen O1 device and accessories..... | 35 |
| 10.1. Mobile device requirements | 35 |
| 10.2. Technical features of the echOpen O1 device and echOpen ON application..... | 36 |
| 10.3. Probe battery charger | 36 |
| 10.4. Environmental operating and storage conditions | 36 |
| 10.5. Electromagnetic compatibility (ECM)..... | 37 |

10.6. Separation distances38

10.7. Acoustic emissions39

11. Pictograms40

1. About echOpen O1

1.1. Overview

This manual provides information that allows Users **with appropriate training** to use the echOpen O1 device and the dedicated application echOpen ON safely and effectively.

The manual must be read and understood in its entirety **before** using the device and particular attention **must** be paid to the warnings given throughout the manual.

This manual **must** be kept for the entire duration of use of the echOpen O1 device.

1.2. Intended Purpose

echOpen O1 is a handheld ultrasound imaging device intended for Point-Of-Care Ultrasound (POCUS) in adult patients in order to allow ultrasound imaging of organs and tissues of the human body.

echOpen O1 includes a tri-frequency ultrasound probe to be used with a dedicated software application on a connected mobile device (smartphone / tablet).

The device is to be used by trained Healthcare Professionals.

echOpen O1 is intended to complement the standard clinical examination by providing ultrasound imaging findings and to locate vessels prior to catheterization.

echOpen ON is an accessory software application intended to control and present output information from a dedicated ultrasound probe in order to fulfil its intended purpose.

1.3 Intended use environment

The echOpen O1 device is intended to be used in the following environments:

- Hospital environments (including emergency wards and other relevant wards).
- General care environment (private practice facilities, public care facilities, remote area facilities, and nursing homes).

1.4 Target patient population

The echOpen O1 device is intended for patients requiring a standard clinical examination, including ultrasound imaging of organs and tissues in the human body. See limitations and contraindications below.



The echOpen O1 device is not intended for use as a self-sufficient diagnosis tool. Interpretation of the obtained images **must** be made in a specific clinical situation.

It is contraindicated to only consider the information from the ultrasound examination without taking into consideration the clinical context of the patient as a whole.

The echOpen O1 device is **not** intended for use for measurement or monitoring purposes.

The echOpen O1 device must **not** be used for intravaginal or any other form of invasive examination.

The echOpen O1 device is **not** intended for use on mucous membranes or damaged areas of the skin.

The echOpen O1 device is **not** intended for use on eyes examinations.

The echOpen O1 device is **not** intended for use in the following environments: emergency vehicles and private homes.

1.5. Indications

The echOpen O1 device is indicated for Point-Of-Care Ultrasound (POCUS) which complements the standard clinical examination by providing ultrasound imaging findings.

The following targets and the related clinical conditions are examples of what can be visualized:

| ANATOMICAL AREAS | ORGANS | CLINICAL CONDITIONS |
|---|-------------------|--------------------------|
| Thorax (Adult) | Lung | Pleural effusion |
| | Heart | Pericardial effusion |
| Abdominal & Pelvis (Adult) | Peritoneum | Abdominal effusion |
| | Vessels | Abdominal aorta aneurysm |
| Protocols (Adult) | FAST, eFAST | Pleural effusion |
| | | Abdominal effusion |
| | | Pericardial effusion |
| Location prior to catheterization (Adult) | Big vessels | Internal jugular |
| | | Common femoral |
| | | Subclavian |
| | Peripheral access | Basilic Vein |

1.6. Contraindications

The echOpen O1 device is **not** intended to be used in the following populations or conditions:

- For diagnostic ultrasound in pediatrics, fetal, neonates, and / or infants.
- For the guidance of a needle-guided biopsy and catheterization.
- For an ultrasound scan of the face or skull.
- For ophthalmologic ultrasound.
- For osteoarticular ultrasonography.
- For either thoracic or abdominal diagnostic ultrasound in obese patients (Body Mass Index >34.9 kg/m²).
- Any time that the patient's life is at stake, requiring emergency medical care.

1.7. Training

The intended Users of echOpen O1 and echOpen ON are Health Care Professionals (HCPs) trained and qualified in using ultrasound technology according to national laws / guidelines and / or local requirements.

1.8. Benefits and Risks of the Device

Benefits

- echOpen O1 improves and secures catheterizations by providing images that enable the User to locate blood vessels.
- The use of echOpen O1 enhances the standard clinical examination (inspection, palpation, percussion, and auscultation) by providing ultrasound imaging findings.

Risks

The risk of ultrasound is low due to non-ionizing radiation technology which has been used in the medical field for several decades. Prolonged exposure to ultrasonic waves may result in slight warming of human tissues. Always apply the ALARA principle (As Low As Reasonably Achievable) to limit ultrasound exposure.

Exposure time and acoustic power should be kept as low as reasonably possible, whilst allowing for the collection of acceptable diagnostic images for medical purposes.

Sonographers must respect the ALARA principle during POCUS clinical examinations and pay particular care to the surface of the lung for thin patients and / or patients treated with specific drugs.

Essential Performance

Essential performances of the echOpen O1 device are compliant with standard EN 60601-2-37:A1:2015, Medical electrical equipment - Part 2-37: Particular requirements for the basic safety and essential performance of ultrasonic medical diagnostic and monitoring equipment.

2. Safety Guidelines

2.1. Introduction

The following instructions apply to the echOpen O1 probe and its dedicated mobile application echOpen ON. This information **must** be read, in its entirety, before using the echOpen O1 device.

2.2. Basic safety of the echOpen O1 device and its accessories



Do not use the echOpen O1 device without the correct professional training. Always use clinical judgement when interpreting images obtained using the echOpen O1 device.

Do not use the echOpen O1 device until you have read and understood this manual in its entirety.

Do not use the echOpen O1 device for purposes other than those specified in this manual.

Failure to follow the safety instructions specified in this manual can result in serious injury or death.

Do not use the echOpen O1 device if the package is opened or damaged. Always inspect the probe before and after each time it has been cleaned / disinfected and / or used and check for any signs of degradation (cracks, abrasions, and leaks).

Do not use the probe if it shows any signs of deterioration. Only use accessories provided by echOpen Factory. The use of any accessories, such as cables and chargers, other than those specified and / or supplied by the manufacturer, can lead to device malfunction.

The list of compatible mobile devices is available online via www.echopen.com/support/O1/compatibility.

Do not use the echOpen ON application (echOpen ON app) on a mobile device that does not have characteristics listed in Section 10.1: Mobile device requirements.



Using third-party applications on the same mobile device as the echOpen ON app can affect the performance of the application.

If this issue occurs, it is recommended that the echOpen ON application is installed on a dedicated mobile device intended to be used solely for this purpose.

In case of any malfunction of the mobile device, the User must follow a suitable medical examination protocol without ultrasound examination.

The echOpen O1 device is not compatible with magnetic resonance.

It may cause unacceptable risks to the patient, medical staff, or anyone else present in the magnetic resonance environment.



The echOpen O1 device usage is alternating periods of 2 minutes with probe **ON** followed by periods of 15 minutes with probe **OFF**.

Only the probe nose and the ultrasound gel should come into direct contact with the patient's intact skin. See Section 3.1: Components of the device.

Do not leave the probe in contact with the patient's skin once the ultrasound examination is completed.

Stop using the probe in the event of leakage, overheating, odor, or smoke. Contact the manufacturer and set aside the probe using appropriate and effective equipment, pending the intervention of qualified personnel for inspection, testing and replacement of the device if necessary.

Do not allow any liquid to enter the probe. Any entering of liquid into the device can damage it and cause a risk of fire or electric shock.

Do not attempt to open the probe or manipulate the internal components of the device, including the battery, as this may cause injury to the patient or User.

The use of damaged equipment or accessories may cause the device to malfunction and / or cause injury to the patient or User.

Ensure maintenance is carried out by fully trained staff.

No alterations must be carried out on the device.

Do not modify cables, cases, batteries, probes, chargers, or specified accessories to be used with the echOpen O1 device.

Any changes to the equipment may cause the system to malfunction or cause injury to the patient or operator.

2.3. Use environment safety



Do **not** use the probe in the presence of flammable gases, anesthetics, or near a source of heat or fire.



Portable and mobile Radio Frequency (RF) communication devices can affect medical electro devices.

Do not use RF communication devices within 30 cm of **any** part of the echOpen O1 device, including accessories provided by the manufacturer, in order to avoid device degradation.

2.4. Electrical safety



Do **not** use the device if the charger is connected to it. The use of the probe connected to its charger can cause electric shock.

The probe nose only can be immersed. See Section 6.1: Cleaning and disinfection, Fig.12.

Do **not** submerge or spray the **entire** probe.

Immersion or sprinkling of the entire probe can cause electric shock.

Always inspect the probe before and after each cleaning, disinfection or use to detect any signs of deterioration (cracks, abrasions, and leaks).

To avoid the risk of electrical hazards, do not use the probe if it shows signs of deterioration.

Always inspect the charger before use. Do not use if there are any signs of degradation. The use of a damaged charger can cause electrical shock.

The operation of the echOpen O1 device implies the presence of high voltages.

No parts should be repaired by the User.

Do **not** attempt to open the probe case. Do **not** handle the probe if the case is broken.

Contact the manufacturer and set aside the probe using appropriate and effective equipment, pending the intervention of qualified personnel for inspection, testing and replacement of the device if necessary.



The use of accessories (cables, chargers, etc.) other than those specified or supplied by the manufacturer may lead to an increase in electromagnetic emissions or a decrease in electromagnetic immunity of the equipment and cause the device to malfunction.

2.5. Security in case of defibrillation



Remove all items in contact with the patient before applying a high voltage defibrillation pulse. Single-use probe protection does not protect against defibrillation.

2.6. Equipment protection



The probe must be cleaned and disinfected **IN BETWEEN EACH USE** with the appropriate detergent according to the maintenance procedures specified in this manual. See Section 6.1: Cleaning and disinfection.

In the event of a fall, immediately stop using the echOpen O1 device. Inspect the probe for signs of deterioration and visually check for sharp edges.

Do **not** use the probe if it shows signs of deterioration.

Do **not** use the probe outside of the environmental operating conditions specified in this manual. See Section 10.4: Environmental operating and storage conditions.



Between each use, store the probe safely away from danger, contamination, and damage, in an environment specifically dedicated to its storage such as the User's pocket or bag.

Do **not** store the probe in full sunlight or in environments that are too hot or too cold.

Do **not** store the probe outside the environmental storage conditions specified in this manual. See Section 10.4: Environmental operating and storage conditions.

To avoid any risk of loss and / or deterioration, it is recommended that the charger is stored safely and in close proximity to the probe.

Do **not** sterilize or autoclave the echOpen O1 device.

2.7. Biological safety



The echOpen O1 probes do not at any time deliver dangerous ultrasound levels in normal use.

Always inspect the probe before and after each cleaning, disinfection or use to detect any signs of degradation (cracks, abrasions, and leaks). Do not use the probe if it shows signs of deterioration.

Only the probe nose and the ultrasound gel should come into direct contact with the patient's intact skin. See Section 3.1: Components of the device, Figure 1.

Do **not** leave the probe in contact with the patient's skin once the ultrasound examination is completed.

The probe is not intended for use in a sterile environment or in contact with non-intact skin or mucous membranes.

The following information is given for informational purpose only.

Protect the probe with an adapted single-use protection such as KRYSTAL COVER™ - SUPERFICIAL PROBES PROTECTION (ref. YPE1830) or Scanning Cover Varay Laborix (ref. PDS5080) if there is any possibility of the device coming into contact with non-intact skin or mucous membranes.

2.8. Operator safety



The User must follow the procedures in place of the institution in which the device is being used regarding Personal Protection Equipment (PPE) and infection prevention.



In particular, it is recommended gloves are worn when using the echOpen O1 device in order to avoid contamination.

The User must follow the specified hand sanitizing recommendations in place of the institution in which the device is being used, between each use of the echOpen O1 device.

Prolonged use of the device in a non-ergonomic position can cause fatigue and tension in the User's hands, arms, and neck. Appropriate measures should be taken to ensure the User's comfort and safety.

2.9. Patient data protection



The User of the echOpen O1 device has a duty to inform the patient and to ensure patient consent before any use of the echOpen O1 device results in the recording of patient data.

The User of the echOpen O1 device is the only individual held responsible in the case of data sharing.

It is recommended that the User refer to the regulations in force in the country in which the device is being used.

For European Union country members, refer to Regulation (EU) 2016/679 (General Data Protection Regulation).

It is recommended that patient data is protected by fully encrypting the personal mobile device being used via a secure password / passcode.

The echOpen ON application itself is equipped with ID, password, or PIN authentication. To ensure strong authentication, the User's password must contain a minimum of 12 characters, including at least one uppercase, one lowercase, and one digit.

To ensure optimal protection of patient data, the echOpen ON application disconnects after 15 minutes of inactivity.

It is then necessary for the User to enter the PIN again.

3. Introducing the echOpen O1 device and accessories

3.1. Components

The echOpen O1 device is a handheld ultrasound imaging device intended for Point of Care Ultrasound. It consists of several elements:

- The echOpen O1 ultrasound probe.
- The echOpen ON app.
- The probe battery charger.

The use of the echOpen O1 device requires a smartphone, referred to in this document as a mobile device. See Section 10.1: Mobile device requirements.

The probe and charger are supplied with the echOpen O1 device. Before any use, ensure that each element of the device is identified and verify that all the elements are present

3.1.1 Probe

The echOpen O1 device includes a three-frequency probe to be used with the dedicated echOpen ON application.

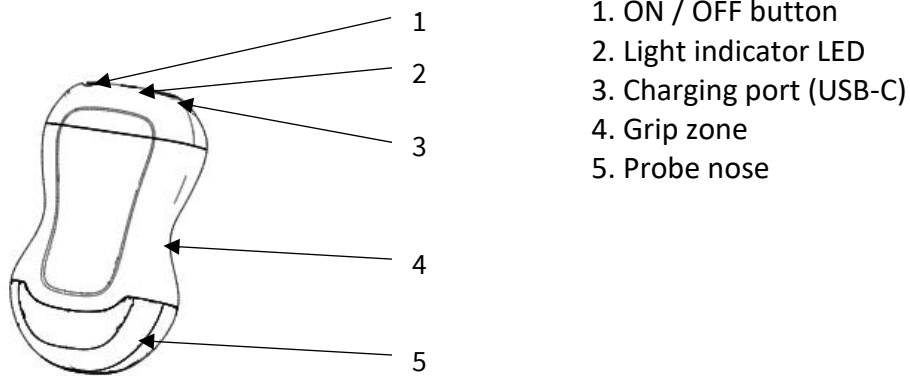

- 1. ON / OFF button
- 2. Light indicator LED
- 3. Charging port (USB-C)
- 4. Grip zone
- 5. Probe nose

Figure 1 : echOpen O1 probe

3.1.2 Applied parts

Applied parts refer to the parts of the echOpen O1 device which come into physical contact with the patient in order for the device to carry out its intended functions.

These are applied parts of type BF (isolated patient connection).



Only the probe nose and the ultrasound gel should come into direct contact with the patient's intact skin.

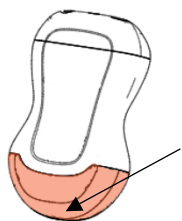

Probe nose: direct contact with patient's skin

Figure 1b : echOpen O1 probe

3.1.3 Mobile device

The mobile device is used to display images acquired by the probe.

A Wi-Fi connection, generated by the echOpen O1 probe, is used for communication between the mobile device and the probe.



Using third-party applications on the same mobile device as the echOpen ON app can affect the performance of the application. If this issue occurs, it is recommended that the echOpen ON application is installed on a dedicated mobile device intended to be used solely for this purpose.

In the event of malfunction of the mobile device, the User must resort to a suitable medical examination without ultrasound examination.



The mobile device can be placed on a stand for better grip during the exam.

If a phone call is answered on the mobile device during a consultation, the consultation ends, and the media is saved.

3.1.4 echOpen ON application

The echOpen ON application allows the User to control the consultations and visualize organs and tissues of the human body.

The echOpen ON app is downloadable from the Google Play store, the Apple App store, or any other controlled broadcasting system used by the User's organization.

It is necessary to create a personal echOpen account to be able to connect to the application.



The list of compatible mobile devices is available online via:
www.echopen.com/support/O1/compatibility.

Do **not** use the echOpen ON application (echOpen ON app) on a mobile device that does not have the characteristics listed in Section 10.1: Mobile device requirements.

3.1.5 Probe battery charger

The battery charger is used to charge the probe's battery.

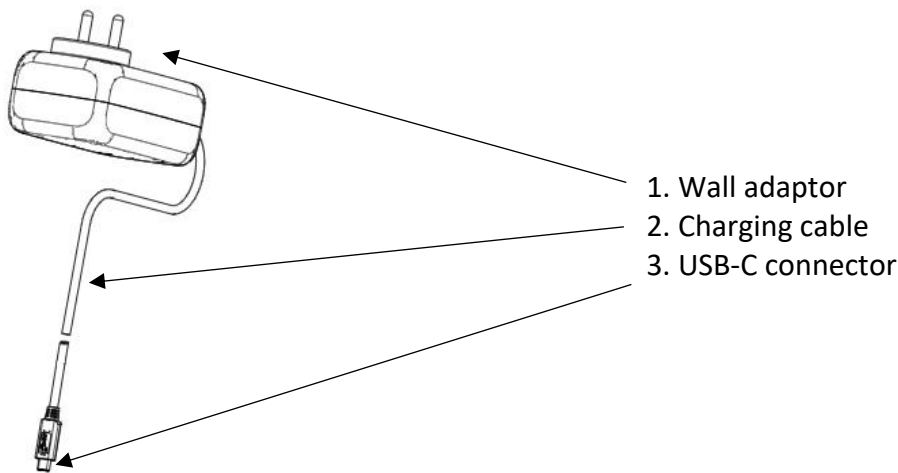

Figure 2 : Probe battery charger



Always inspect the charger before use. Do **not** use if there are any signs of degradation. The use of a damaged charger can cause electrical shock. Use only the charger supplied by the manufacturer.

3.2. Internet connectivity

No internet connection is required during the consultation.



Once the echOpen ON app is connected to the probe, the User's mobile device disconnects from the Wi-Fi network or mobile data because the connection between the probe and the device uses a Wi-Fi connection generated by the probe.

If the User's facility uses Wi-Fi-connected devices for emergency communications, it is recommended these devices are **not** used for the echOpen ON application.

When the probe is connected to the mobile device, no emergency communication connected to the Wi-Fi network can be received.



An internet connection is required in order to download the echOpen ON app and install updates.

It is necessary to connect the application to the Internet **at least** every 90 days to ensure that it has the latest security updates.

4. Start and set up of the echOpen O1 device

4.1. Charging the probe



The probe **MUST** be fully charged (100%) before it is used for the first time.

The probe **MUST** be unplugged from the charger before any use.

The use of the probe connected to its charger can cause electric shock.

Only accessories provided by echOpen should be used.

The use of accessories (cables, chargers, etc.) other than those specified or supplied by the manufacturer can lead to malfunctions.

Always inspect the probe before recharging to detect any signs of degradation (cracks, abrasions, and leaks).

Do **not** recharge the probe if it shows any signs of deterioration.



In order to keep the probe sufficiently charged, it is recommended it is recharged at the end of each day's use.

To recharge the probe:

1. Connect the charger provided to the probe's USB C port.
2. Plug the wall adaptor at the other end of the charger into a power outlet.
3. The probe's LED light turns orange to indicate that the probe is charging. Charge the probe until the light turns green.

4.2. Checking the probe's battery level

To check the probe's battery level while charging:

When the probe is connected to the charger, the color of the probe's light indicates if the battery is charged.

| Loading level | Color of the LED light | Profile of the light indicator |
|---------------------------|------------------------|--------------------------------|
| Battery charging (0-99%) | Orange | Continuous |
| Battery charged (99-100%) | Green | Continuous |

To check the probe's battery level using the echOpen ON app:

- Once the probe is connected to the echOpen ON app, its battery level appears on the home screen in the **My Probe** section, as shown on Figure 3.a.

During the consultation, the probe's battery level is displayed at the top left of the screen (Figure 3.b).

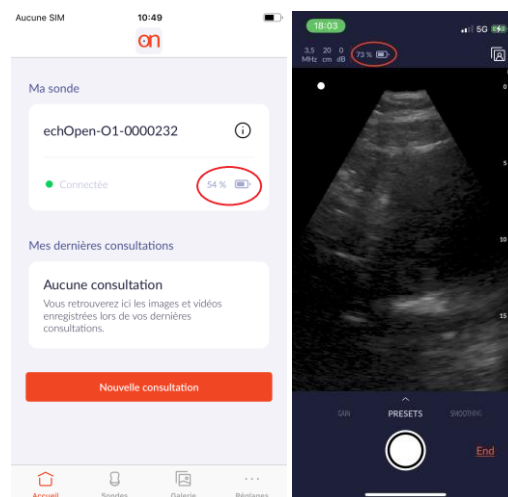

Figure 3.a (on the left): Battery level - Home screen
Figure 3.b (on the right): Battery level - While scanning



If the battery level is too low, it may be necessary to recharge the probe before starting a new consultation.

If the probe's battery level is below 2%, the probe automatically shuts down.

4.3. Creating an echOpen account

Before using the echOpen O1 device it is necessary to create a personal echOpen account by going to the following address: my.echopen.com/register.

The account ID and password allows the User to access all echOpen services.

The password can be changed at any point by clicking on "Forgot password" on the screen.

4.4. echOpen ON app download and installation

The echOpen ON app can be downloaded from the Apple App Store or Google Play Store from the mobile device.

To do this, go to the store compatible with the device and enter «echOpen ON» in the search field to download and install the application.

4.5. First connection



Ensure the probe is fully charged (100%) before it is used for the first time (cf. section 4.1)

It is necessary to pair the probe with the echOpen ON app when the User first logs in. This step is required only once per probe.

The application remembers the already paired probes for future uses.

1. Open the echOpen ON app
2. Login using the echOpen account's login and password selected.
See Section 4.3: Creating an echOpen account.
3. Set up a PIN code and biometric authentication (if available) for secure access to the echOpen ON app.
4. Adjust the mobile device's brightness. to best distinguish the 16 different shades of gray (see Figure 4). You can adjust the screen brightness from the mobile device's settings. The calibration screen is displayed only at first connection.

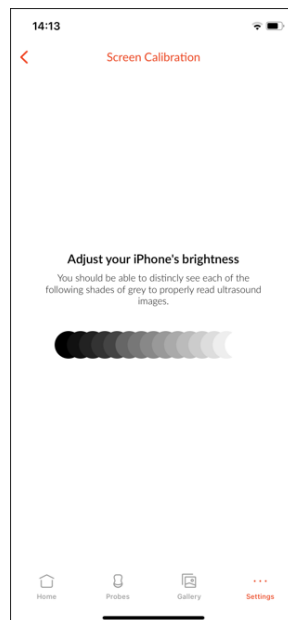

Figure 4: Gray level calibration

5. Allow all necessary permissions for the echOpen ON app (geolocation, camera, and local network).
6. Turn on the probe once it has been sufficiently charged by pressing the ON / OFF button.

7. Pair the probe and the echOpen ON app by scanning the probe's flash code on the label(see Figure 5).

If the probe cannot be paired by scanning the flash code, it can be paired manually.

See Section 4.7: Manage my probes.

Make sure geolocation is turned **ON** to allow Wi-Fi connection between the probe and the mobile application.



Make sure the 16 grey levels on the calibration screen can be clearly visualized before starting a consultation.

Do **not** use echOpen O1 device if this is not the case.

Poor grayscale calibration can affect the performance of the device.

If there are any doubts about the rendering quality of the User's screen, the calibration screen can be found in the app's "Settings".

4.6. Changing the PIN - My Account

The PIN can be changed from the **My Account** tab on the main menu.

The **My Account** tab also shows the echOpen account information.

4.7. Manage My Probes

For more information on the probes that have already been used, press the **My Probes** tab.

If a probe is connected to the echOpen ON app, the battery level, the strength of the Wi-Fi connection and access to the identifying SSID can be viewed by clicking on the information icon.

The **My Probes** menu also allows the User to view the list of probes already paired with the app.

Delete a probe from the list

To delete a probe from the list of probes already paired with the app, click on the information icon of the corresponding probe in the **My Probes** menu.

Click **FORGET THE PROBE**.

Manual pairing

If the probe cannot be paired to the app by scanning the slash code, click the **MANUAL ENTRY** button at the bottom of the pairing screen.

Enter the probe's UDI displayed on the back of the probe (next to the flash code on the right) and click **PAIR**.

4.8. Changing the language

To change the language of the app, select the Language tab.

The preferred language can then be selected from the list.

4.9. Disconnect from echOpen ON application

To log out of the app, click the **DISCONNECT** button. The app then logs out of the echOpen account. Log in and password will need to be re-entered at the next connection.

4.10. Managing updates to the echOpen ON app



The echOpen ON app needs to be updated on a regular basis. An internet connection is required to install the latest update of the echOpen ON app.

To ensure optimal and secure use of the echOpen ON app, you are responsible of updating the mobile device's OS on a regular basis, at least once a month.

Updates to the echOpen ON app are available from the Apple App Store or Google Play Store.

Automatic or manual updates to the echOpen ON app can be set up from the mobile device settings.

If the mobile device is configured to automatically update its apps, the echOpen ON app will automatically update each time a new update becomes available.

If manual updates have been chosen, updates will need to be regularly installed to the app from Apple's App Store or Google Play Store.

Concerning the firmware update, meaning the software embedded in the probe, you shall accept the updates coming only from the echOpen ON application.

5. Use of the echOpen O1 device

5.1. Precautions before use

Reminder:

Before and for each use, the user must ensure that:

- The probe and mobile device are charged according to the instructions provided in sections 4.5. *(if the mobile device battery is too low, there is a risk of interruption during an examination)*
- There is sufficient ultrasound gel available nearby.

5.2. New consultation

1. Turn on the probe.
Be aware that the Wi-Fi of the probe takes some seconds to start.
During these seconds, you cannot connect to the probe with the app.
The probe's LED flashes slowly in blue when searching for a connection.
2. Open the echOpen ON app and connect to the probe.
3. If it is the first connection with a particular probe, you need to first pair the probe and echOpen ON app. See Section 4.5: First connection.

4. Click on the **NEW CONSULTATION** button at the bottom of the home screen to start the ultrasound examination (Figure 6).
5. The exam starts automatically with a set of default settings that can be changed during the consultation.



Figure 5 : Home screen

5.3. Settings



At the beginning of the consultation, **always** start the ultrasound examination by identifying a recognizable anatomical structure to ensure the quality of the image displayed. If **no anatomical structure** can be recognized, **stop** the examination.

Presets

The echOpen ON app provides **several presets**.

To choose one of them, select the **Presets settings** at the bottom of the screen:

1. **Select** the **preset** of your choice:
 - Abdominal (*using the 3,5 MHz transducer*)
 - Lung (*using the 5 MHz transducer*)
 - Superficial (*using the 7,5 MHz transducer*)
 - Heart (*using the 3.5 MHz transducer*)
 - Bladder (*using the 3.5 MHz transducer*)
 - Vascular (*using the 7.5 MHz transducer*)

2. **Adjust the display zoom** by sliding vertically on the screen.
The entire screen surface can be used to adjust the zoom on the acquired image.

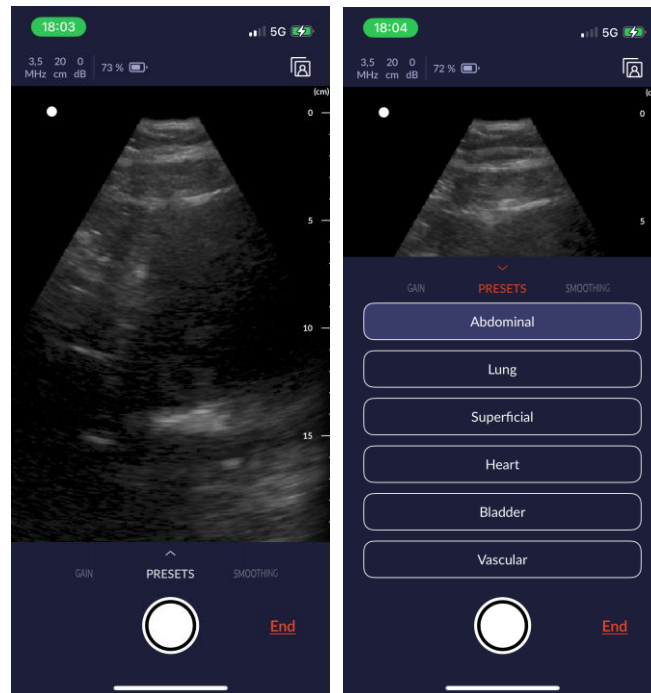

Figure 6: Presets setting

Gain

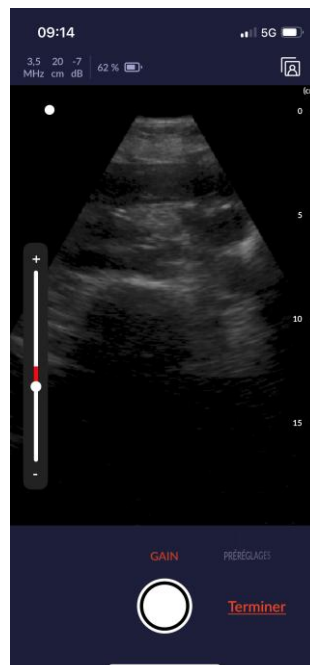

Figure 7: Gain setting

To adjust the gain, select the **Gain** setting at the bottom of the screen: a **lateral slider** will appear on the **left** of the **screen**.

The **gain can then be adjusted** by sliding vertically on the screen.

The **entire screen surface can be used** to adjust the **gain**.

Smoothing

The smoothing setting aims at making the acquired images more visually appealing.

When **selecting a preset during a consultation**, the **smoothing** is activated **by default** for the following presets: **Abdominal, Heart, Superficial, Bladder and Vascular**.

It was **deactivated by default** for the **Lung** preset. This **setting is optional**.

To **adjust the smoothing**, select the **Smoothing setting** at the **bottom** of the screen.

A **drop-down menu** appears on the screen. You can **choose to active or deactivate** the **smoothing**.

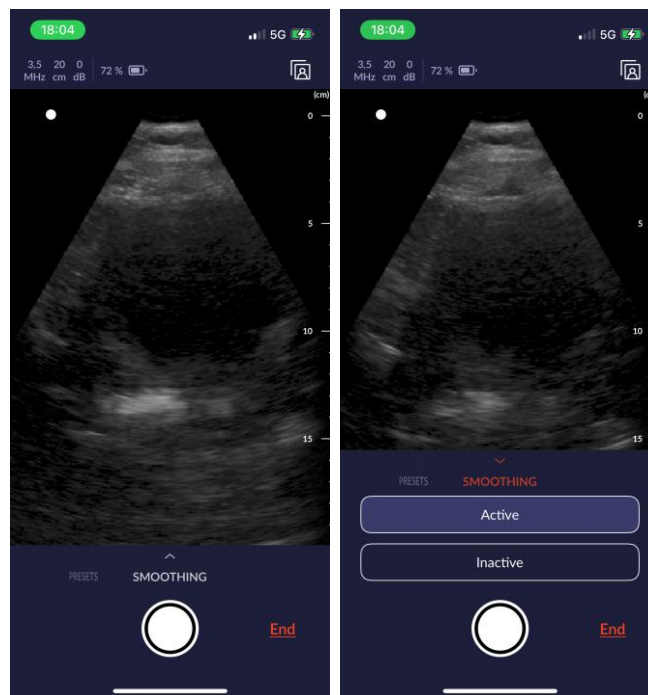

Figure 8 : Smoothing setting

5.4. Creating images and video loops

Images

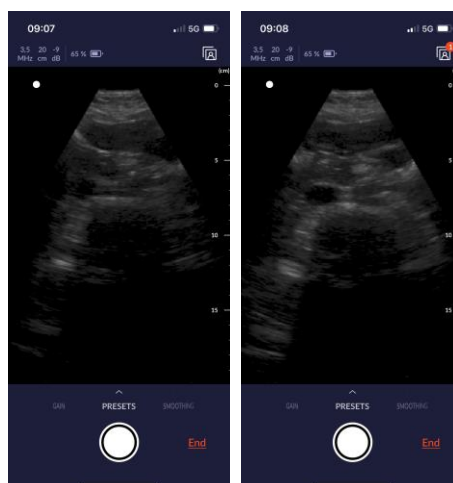

Figure 9: Images

Press the button  once to save an image.

A sticker appears at the bottom left of the screen to display the number of media saved during the consultation.

Video loops

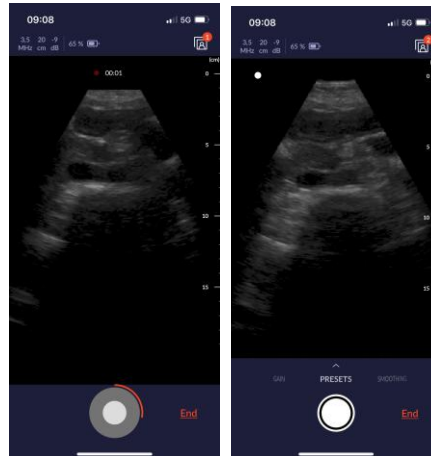



Figure 10: Video Loop

Hold the button  to record a 5 second video loop.

5.5 End the consultation

Press the **END** button at the bottom right of the screen to end the consultation.

If any media was saved during the consultation a preview of all recorded media and entered patient information can be previewed before the consultation is ended.

Media can also be deleted by clicking once on the deleted button at the right upper corner of the image.

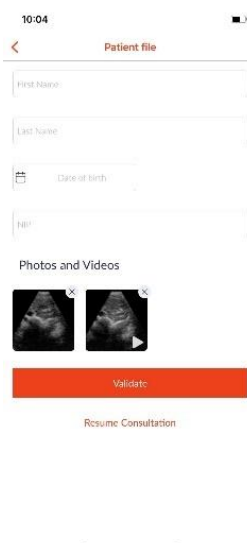

Figure 11: End of consultation

Patient information is not required to save a consultation, however adding it will make it easier to distinguish between consultations when searching through many of them.

If no media was saved, the User will be immediately redirected to the home screen.



The probe automatically disconnects from the application at the end of the consultation to allow the synchronization of the media with the echOpen platform.

The synchronization stops automatically when a new consultation is started, and resumed the next time the app is opened while connected to internet.

An internet connection is required for synchronization.

Back-up preferences (Wi-Fi, Mobile Data) can be selected in the settings of the application.

If there is no access to an internet connection at the time of the consultation, synchronization will automatically start the next time the app is opened while connected to the internet.

Do not forget to turn off the probe after each use.

5.6 Adding information



Adding information to consultations in the echOpen ON app is no substitute for the patient follow-up protocol in the User's facility.

Patient information can also be added later when selecting the consultation in the gallery.

To add information from the gallery:

Go to the **Gallery** tab. Once in the gallery, select the consultation in question and click on **MODIFY**. This gains access to the same features as at the **End of Consultation** screen.

See Section 5.5: End the consultation.

5.7. View my consultations

To view previous consultations, go to the **Gallery** tab from the main menu. The latest consultations can also be accessed directly from the home screen.

All personal and medical recorded information in the echOpen ON app is encrypted and only viewable by the User using the personal, password-protected account.

Gallery

Once in the gallery, there is the option to display the media using **FILES** or **PHOTOS**.

The **FILES** view gives access to images and videos grouped by consultation. The User can also access and edit the added information. The consultations are sorted from the most recent to the oldest.

The **PHOTOS** view allows the User to see all images and videos sorted in date order.

Images and videos remain available for 90 days in the echOpen ON app. Beyond this retention period the media are deleted from the application. Be sure to sync all media with the echOpen platform before it is deleted.

The synchronization is automatic at the end of the consultation if there is internet connection. Back-up preferences (Wi-Fi, Mobile Data) can be selected in the App Settings.

If there is no access to an internet connection at the time of the consultation, synchronization will automatically start the next time the app is opened while connected to internet.

echOpen platform

All synchronized media are accessible on echOpen platform.

Link to the echOpen platform is available in settings of the application and in the gallery.

6. Maintenance of the echOpen O1 device

6.1. Cleaning and disinfection



It is the User's responsibility to appropriately clean and disinfect the mobile device in accordance with the device manufacturer's instructions and with the policies of the User's institution for the cleaning and disinfecting of medical devices.

It is essential to disinfect the probe echOpen O1 **IN BETWEEN** each use.

The probe nose only can be immersed (see Figure 12 below).

Do not submerge or spray the entire probe or charger.

Immersion or sprinkling can cause electric shock.

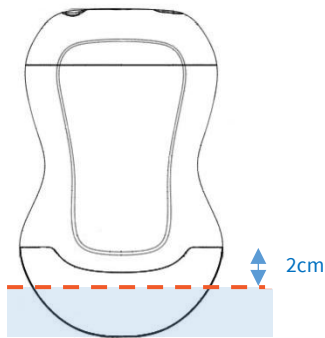

Figure 12 : Immersion limit of echOpen O1 probe

Cleaning and Disinfection of the echOpen O1 probe

The cleaning and disinfection classification depends on the type of tissue the echOpen O1 probe comes into contact with according to the Spaulding classification. Refer to Table 1 to determine the appropriate cleaning and disinfection level.

Table 1 : Spaulding classification

| Class | Usage | Cleaning and disinfection |
|--------------------|-----------------------------|--|
| Non-critical class | In contact with intact skin | Followed Intermediate-Level Disinfection (ILD) |

Cleaning of the probe

It is essential to remove any traces of ultrasound gel or other particles before proceeding with the disinfection of the probe.

1. Make sure the probe is turned **off** and **disconnected** from the charger **before** cleaning is started.
2. Remove the gel using lint-free cloth.
3. Clean the probe nose with soapy water until the probe is visibly clean and rinse with water.
4. Dry the probe with a lint-free cloth.
5. Visually inspect the probe to ensure all surfaces are clean. Repeat the operation if necessary.

Intermediate Level Disinfection

It is recommended that Super Sani-Cloth® Wipes supplied by the sponsor are used.

1. Clean the probe nose with soapy water and rinse thoroughly with water.
2. Dry the probe with a lint-free cloth.
3. Clean the probe with disinfecting wipes (Super Sani-Cloth® Wipes) and leave it on for 2 minutes.
4. Dry at room temperature.
5. Rinse carefully with a water-soaked lint-free cloth then rinse thoroughly with water.
6. Dry the probe with a lint-free cloth.

6.2. Device Storage

Between each use, store the probe safely away from danger, contamination, and damage, in an environment specifically dedicated to its storage such as the User's pocket or bag.



Do not store the probe in full sun or in places that are too hot, too cold, or too humid.

Do not store the probe outside the environmental storage conditions specified in this manual.

See Section 10.4: Environmental operating and storage conditions.

To avoid any risk of loss, it is recommended the charger is stored in close proximity to the probe.

7. Recycling and disposal

The echOpen O1 device is part of the 2002/96/EEC Directive on Electrical and Electronic Equipment Waste (EEE) and national legislation.



At the end of its life, the echOpen O1 device should be disposed of in a specifically authorized processing facility and should be disposed of as unsorted municipal waste.



The echOpen O1 device complies with the RoHS Directive 2011/65/EU on limiting the use of certain hazardous substances in electrical and electronic equipment and the EU REACH regulation to protect human health and environment from chemical risks.

8. Troubleshooting



Stop using the probe in case of leakage, overheating, selling, irregular noise or smoke.

Do **not** use the probe if it shows signs of deterioration.

The use of damaged equipment or accessories can cause the malfunction of the device and / or cause injury to the patient or User.

Do **not** attempt to open the probe or manipulate the internal components of the device, including the battery, otherwise the patient or the operator may be injured.

No parts should be repaired by the User.

Do not attempt to open the probe case.

Maintenance should only be carried out by qualified staff.

Do not handle the probe if the case is broken.

Table 2 lists the most common problems and their resolution. If the problem cannot be solved, please contact echOpen. See Section 9: echOpen support.

Table 2 : Troubleshooting

| Frequent problems | Cause | Solution |
|--|---|---|
| First use | | |
| The app refuses to install on my mobile device. | Your mobile device or your version of Android / iOS is incompatible with the app. | See the device compatibility list online: www.echopen.com/support/O1/compatibility See Section 10.1: Mobile device requirements or contact support at echOpen. |
| The app asks for an ID and password. I do not know them. | To use the app, you need to have created an echOpen account. | Go to https://my.echopen.com/register to create your account If you forget your password, you can create a new one. Click on "Forgot password" when logging into the application. |
| The app starts and stops immediately. | There is an incompatibility between your mobile device and the app. | Contact support. |

| | | |
|--|--|---|
| | A third-party app affects how the echOpen ON app works. | Close all other open apps on your mobile device. |
| My mobile device fails to read the flash code. | Unreadable flash code. | Pair the probe manually. See Section 4.6: Manage My Probes. |
| | Faulty photo module. | Make sure the photo module lens is clean. If this persists, pair the probe manually. See Section 4.6: Manage My Probes. |
| App start | | |
| I can no longer start the app, either with my PIN or with my echOpen ID / password. | You have not validated your IDs recently. | Turn on your internet connection and restart the app. |
| Starting and connecting the probe | | |
| The probe does not start. | Battery discharged. | Recharge the probe before starting it again |
| The probe's light indicator flashes red. | Overheated probe. | Stop the probe and place it in a cool place to let it cool down for a few minutes |
| | Internal error. | <ul style="list-style-type: none"> • Turn off the probe for a few moments. • Restart the probe. • Contact support if the outage continues. |
| The app fails to connect to the probe. | Wi-Fi is disabled. | Turn on Wi-Fi on your mobile device and try again. |
| | Location is disabled. | Geolocation must be enabled to allow Wi-Fi connection between the probe and the app. Make sure geolocation is turned on. |
| | The probe shut down because it took too long to connect. | Restart the probe and try again. |
| The connection to the probe hangs in "connecting". | Processes in the mobile phone may interfere with the connection. | Cancel and restart the connection and if that does not work close completely the app and restart the connection. |
| The app had connected successfully but the probe disconnected and shut down. | The probe shut down because it remained inactive for too long. | Restart the probe and the app should reconnect after a few seconds. |
| The probe starts even though I have not launched a consultation | Auto restart of the probe | The probe should disconnect itself in a few seconds, if not turn the probe off |
| During the exam | | |
| The probe has stopped during examination or the probe refuses to launch a new examination. | Insufficient battery. | Recharge the probe before starting a new exam. |
| | The temperature of the probe nose is too high. | Stop the probe and place it in a cool place to let it cool down for a few minutes. |
| The probe shuts down. | Empty battery. | Recharge the probe before restarting it. |
| The image quality is poor and has random vertical stripes. | There is a Wi-Fi communication problem. | Re-start the probe and re-connect it to the app. |
| | | Move to a place less prone to electromagnetic disturbance. |
| The image quality is poor, and you have | There may be poor contact between the | Add ultrasound gel or use appropriate ultrasound gel. |

| | | |
|--|--|--|
| difficulty perceiving the organs. | probe nose and the patient's skin. | |
| | Manual settings are incorrect. | Adjust the manual settings. |
| The image suddenly shifted sideways. | There has been a shift in the internal mechanism, possibly due to a shock on the probe. | Stop the consultation or restart the probe completely before launching a new consultation. The image should then be centered. If the problem persists, contact support. |
| Black screen | Incompatibility between the application and the firmware inside the probe | Deinstall and reinstall the application. Relaunch the probe's update: it will reinstall the firmware. If this does not work the user will contact the support. |
| Media management | | |
| I cannot find the recorded media. | The mobile device could not save them due to a lack of space. | Free up storage space on your mobile device. |
| | For data protection reasons, the app must remove stored media after a certain time. | Your synchronized media is stored on the echOpen platform. |
| I cannot transfer my media to the echOpen platform. | You need to be connected to the internet when the app is launched so that your media is automatically transferred to the platform. | <ul style="list-style-type: none"> • Check that the probe is disconnected. • Check your internet connection. Syncing should start automatically. |
| Recharging | | |
| The probe's luminous indicator remains orange and will not turn green. | Damaged battery. | Contact support. |
| The probe heats up abnormally. | Damaged battery. | Unplug the charger and place the probe on a cold, non-combustible surface such as tile. Contact support. |
| The probe does not start. | For safety reasons, it is not possible to use the probe while charging. | <ul style="list-style-type: none"> • Wait for the charging to be finished. • Unplug the probe. • Turn on the probe. |
| Other alerts and messages from the app | | |
| The probe encounters an error. Please restart the probe and start a new consultation. | There is a technical issue with the probe. | Stop the probe for a few minutes before turning it back on and starting a new consultation. If the error persists, please contact support. |
| The probe is abnormally hot. Please turn it off and wait few minutes before starting a new consultation. | The probe's temperature is too high OR the chip's temperature is too high. | Stop the probe and place it in a cool place to let it cool down for a few minutes. |
| Probe connection is not optimal. If the image quality is impacted, please try to restart your probe. | Poor communication quality between the probe and the echOpen ON app. | Re-start the probe and re-connect it to the app. |
| | | Move to a place less prone to electromagnetic disturbance. |

| | | |
|--|---|--|
| Probe cannot be found. Make sure that your probe is turned on and paired to your mobile app. | Communication between the probe and the echOpen ON app is lost. | Bring the probe closer to the mobile device. |
| | | Move to a place less prone to electromagnetic disturbance. |
| Low battery. Please recharge your probe. | Probe battery status goes below 2% during a consultation. | The probe might stop during consultation. Recharge the probe before starting it again. |
| Low battery. Please recharge your probe before starting a new consultation. | Probe battery status goes below 2%. | Probe battery status is too low to start a new consultation. Recharge the probe before starting it again. |
| Cannot start a consultation. Probe is charging. | The charger is connected to the probe. | For safety reasons, it is not possible to use the probe during charging. Unplug the charger before starting a new consultation or wait until charging is complete. |
| Operation of the probe is impossible. Probe is charging. | The consultation stops automatically because the charger is plugged in during the consultation. | For safety reasons, it is not possible to use the probe during charging. Unplug the charger before starting a new consultation or wait until charging is complete. |
| Media retention period is expiring. Please ensure internet connection to synchronize your media. | Media has not been transferred to the platform. | Check that the probe is disconnected. Check your internet connection. Syncing should start automatically. |
| Disk full? Your disk is full, we could not record this media. Please free some space on your smartphone. | There is not enough space in the storage space of your mobile device to record your consultation. | If you want to save your consultation, free up space on your mobile device. |
| Deletion of media during backup? Deletion of media is not allowed while backup is in progress. | You are deleting media while synchronization is in progress. | Wait for the synchronization to be completed before deleting the media. |
| Location. Please enable and grant location permission to connect to the probe. | Location is disabled. | Geolocation must be enabled to allow Wi-Fi connection between the probe and the app. Make sure geolocation is turned on. |
| Enable Wi-Fi. Please activate your mobile device's Wi-Fi. | Wi-Fi is disabled. | Turn on Wi-Fi on your mobile device and try again. |
| Downloaded. User manual has been successfully downloaded in Downloads file. | The User manual has been downloaded to your mobile device. | You can now consult the User manual at any time from the Downloads file of your mobile device. |

9. echOpen support

Get assistance by contacting our echOpen support service: support@echopen.com

Get support from the echOpen ON app:

Go to the **Help** tab of the echOpen ON app:

- If you have a problem or a question, click on the **FAQ** tab.
- If you cannot find the solution to your problem, send us a message by clicking on the **Report an issue** tab.

10. Technical features of the echOpen O1 device and accessories

10.1. Mobile device requirements



Do not use the echOpen ON application on a mobile device that does not meet the minimum requirements specified below or there is a risk of the performance and quality of the image being affected.

Registered media being viewed is temporarily stored in the app.

We recommend keeping some available space on the mobile device to allow for this temporary device storage.

Each recording is approximately 5MB.

The echOpen ON application works on a large number of Android and iOS smartphones that comply with the following requirements:

Table 3: Mobile Device Requirements

| Mobile Device Requirements | |
|----------------------------|---|
| Brand | iOS: Apple Android: Google, Huawei, OnePlus, Oppo, Samsung, Sony, Xiaomi, Honor |
| OS Version | iOS 17 and above. Android 10 and above. |
| Compatible Chipsets | - See details in www.echopen.com/support/O1/compatibility . |
| Performance benchmark | See details in smartphone compatibility list www.echopen.com/support/O1/compatibility . Scores are retrieved from Geekbench https://browser.geekbench.com |
| Number of pixels | Between 1 Mpix and 5 Mpix |
| Screen ratio | 1.78 and 2.17 |
| Frames per second | The image's refresh rate is an indicator of a smartphone's ability to meet real-time image rendering requirements. Whilst the ultrasound probe produces 10 frames per second, phones that are not capable of rendering more than 9 frames per second are excluded. |

The list of compatible mobile devices is updated on our website:

www.echopen.com/support/O1/compatibility.

Do not use the echOpen ON application (echOpen ON app) on a mobile device that does not have characteristics listed in Table 3.

The echOpen ON application does not work on tablets.

10.2. Technical features of the echOpen O1 device and echOpen ON application

Table 4: Technical Features of the echOpen O1 Device

| echOpen O1 probe characteristics | |
|---|---|
| Probe Dimensions | Approx. 161x99x47 mm |
| Probe Weight | Approx. 400g |
| Power supply | Li-ion battery (rechargeable) |
| Battery characteristics | 7.2 V / 3200 mAh; 23.04 Wh |
| Battery life | ≥ 1 hour in scan mode; ≥ 8 hours without acquisition |
| Recharge | Port USB-C ; 5V@1A |
| Transducers / Frequencies | 3 transducers (3.5 MHz, 5 MHz, 7.5MHz) |
| Expected lifetime | Each echOpen O1 device has an expected lifetime of five (5) years. Expected lifetime is based on a use frequency of 210 days/year and 30 scan cycles per day. |
| echOpen ON app characteristics | |
| Languages | French, English |
| Maximum display depth | |
| 3.5 MHz | 250 mm |
| 5 MHz | 130 mm |
| 7.5 MHz | 60 mm |
| Operating system | Devices running iOS must run iOS 17.0 or a higher version. Android devices must run the Android 10.0 version or a higher version. |

10.3. Probe battery charger

Table 5: Technical Features of the Charger

| Technical Characteristics | |
|----------------------------------|---|
| Manufacturer | CINCON ELECTRONICS CO, LTD |
| Model | TR18RDM050 |
| Input voltage | 80 - 264VAC |
| Output voltage | 5V / 3A |
| Output interface | USB-C |
| Efficiency | 81.84% |
| Protection | Surge protection: protection from continuous short-circuiting |
| Dimensions | 80.40 x 43.00 X 36.90 mm |
| Cable length | ≥ 1800 mm |
| Weight | 115g |

10.4. Environmental operating and storage conditions

Table 6: Environmental Operating and Storage Conditions

| | Operating limits | Transportation and storage limits |
|---|-------------------------|--|
| Temperature | +10°C to +40°C | -20°C to +50°C |
| Humidity | 30% to 90% | 30% to 90% |
| Atmospheric pressure | 700 hPa to 1060 hPa | 700 hPa to 1060 hPa |
| Immersion* | 75 mm | 75 mm |
| * Only the probe nose can be immersed as shown in Figure 12. See Section 6.1: Cleaning and disinfection. | | |

10.5. Electromagnetic compatibility (ECM)

The echOpen O1 device should only be used in the electromagnetic environments specified in the tables below.

The use of the device in an environment that does **not** meet these conditions can degrade the performance of the device.



The use of accessories (cables, chargers, etc.) other than those specified or supplied by the manufacturer can lead to an increase in electromagnetic emissions or a decrease in the electromagnetic immunity of the equipment and cause malfunction of the device.

Table 7: Electromagnetic Emissions

| Emissions test | Compliance | Electromagnetic environment |
|--|---|--|
| Radio frequency emissions, CISPR11 EN55011 | Group 1 | The system uses RF energy for its internal function and for wireless communication in the ISM bands. The RF emissions outside the ISM bands are very low and are not likely to cause any interference in nearby electronic equipment. |
| Radio frequency emissions, CISPR11 EN55011 | Class B | The echOpen O1 device can be used in all establishments, including domestic ones and ones directly connected to the public low-voltage power grid that powers residential buildings. |
| Harmonic Emissions, IEC 61000-3-2 | Non-applicable (no limit for P<75W) | |
| Voltage fluctuations / flicker emissions IEC 61000-3-3 | Non-applicable. Unlikely to produce significant voltage fluctuation and flicker, therefore it is compliant without measurement. | |

Table 8: Electromagnetic Immunity

| Immunity test | Test Level IEC 60601-1-2 | Compliance level |
|--|--|--|
| Electrostatic discharge EN/IEC 61000-4-2 | +/- 8kV contact +/- 2kV, +/- 4kV, +/- 8kV, +/- 15kV air | +/- 8kV contact +/- 2kV, +/- 4kV, +/- 8kV, +/- 15kV air |
| Radiated RF IEC 61000-4-3 | 3V/m 80MHz - 2.7GHz 9 - 28V/m 80MHz - 6GHz | 3V/m 80MHz - 1GHz 9 - 28V/m 80MHz - 1GHz |
| Transitional Electrical rapid salvos EN/IEC61000-4-4 | 2kV Freq 5kHz 2kV Freq 100kHz | 2kV Freq 5kHz 2kV Freq 100kHz |
| Conducted RF 61000-4-6 | 3Veff 150kHz - 80MHz | 3Veff 150kHz - 80MHz |
| Network frequency Magnetic field (50/60 Hz) IEC 61000-4-8 | 30 A/m@50Hz | 30 A/m@50Hz |
| Tension hollows / interruptions in charging mode EN/IEC 61000-4-11 | 0% 10ms 0% 20ms 70% 500ms 0% 5s | 0% 10ms 0% 20ms 70% 500ms 0% 5s |

10.6. Separation distances



Portable and mobile radio frequency (RF) communication devices can affect medical electro devices. The echOpen O1 device **must** be used in an electromagnetic environment where radiated RF disturbances are controlled.

Respect the recommended separation distance when you use portable and mobile radio frequency (RF) communication devices.

Check that the field intensities of fixed RF transmitters, as determined by an electromagnetic site study, are below the compliance level in each frequency range, as shown in Table 8.

The table below shows the recommended separation distances for the echOpen O1 device to be kept away from any radio frequency-transmitting equipment.

Table 9: Recommended Separation Distances by Emission Frequency

| Maximum rated transmitter output (W) | 150 kHz to 80 MHz | 80 to 800 MHz | 800 MHz to 2.5 GHz |
|--------------------------------------|-------------------|---------------|--------------------|
| 0.01 | 0.35 m | 0.12 m | 0.23 m |
| 0.1 | 1.1 m | 0.38 m | 0.73 m |
| 1 | 3.5 m | 1.2 m | 2.3 m |
| 10 | 11 m | 3.8 m | 7.3 m |
| 100 | 35 m | 12 m | 23 m |

Ultrasound scanners can be sensitive to RF interference in the probe bandwidth.

10.7. Acoustic emissions

Thermal and mechanical indexes are under 1.0 for all device settings.

Table 10 : Frequency 3.5MHz, Mode B-mode, 280V

| Index label | | MI | TIS | | TIB | TIC |
|--|-------------------|-----------------------|------------|---------------|------------|------|
| | | | At surface | Below surface | At surface | |
| Maximum index value | | 0.58 | 0.33 | | 0.69 | 0.69 |
| Index component value | | | 0.33 | 0.33 | 0.69 | 0.33 |
| Associated acoustic parameters | pr,a at zMI | (MPa) | 1.04 | | | |
| | W0 | (mW) | | 53.4 | 53.4 | 53.4 |
| | W1x1 | (mW) | | 21.4 | 21.4 | |
| | zs | (cm) | | 2.4 | | |
| | zb | (cm) | | | | 3.8 |
| | zMI | (cm) | 5.62 | | | |
| | zpiia | (cm) | 5.62 | | | |
| | fawf | (MHz) | 3.25 | 3.25 | 3.25 | 3.25 |
| Other information | prr | (Hz) | 1280(a) | | | |
| | srr | (Hz) | 10 | | | |
| | npps | | 1 | | | |
| | lpa,a at zpii,a | (W/cm ²) | 887.6 | | | |
| | lspta,a at zpii,a | (mW/cm ²) | 0.71 | | | |
| | lspta,a at zpii | (mW/cm ²) | 2.56 | | | |
| | pr at zpii | (MPa) | 1.96 | | | |
| b) The pr value reported correspond to the product of the frame rate and the number of lines per frame, which is the maximum number of pulses fired per second in all directions | | | | | | |

Table 11 : Frequency 5MHz, Mode B-mode, 280V







| Index label | | MI | TIS | | TIB | TIC |
|---|-------------------|-----------------------|---------------------|---------------|------------|------|
| | | | At surface | Below surface | At surface | |
| Maximum index value | | | 0.26 | | 0.45 | 0.45 |
| Index component value | | | 0.26 | 0.26 | 0.45 | 0.26 |
| Associated acoustic parameters | pr,a at zMI | (MPa) | 1.38 | | | |
| | W0 | (mW) | | 0.7227.6 | 27.6 | 27.6 |
| | W1x1 | (mW) | | 10.9 | 10.9 | |
| | zs | (cm) | | 1.52 | | |
| | zb | (cm) | | | | 2.76 |
| | zMI | (cm) | 3 | | | |
| | zpii,a | (cm) | 3 | | | |
| | fawf | (MHz) | 4.95 | 4.59 | 4.59 | 4.59 |
| Other information | prr | (Hz) | 1280 ^(a) | | | |
| | srr | (Hz) | 10 | | | |
| | npps | | 1 | | | |
| | lpa,a at zpii,a | (W/cm ²) | 1453 | | | |
| | lspta,a at zpii,a | (mW/cm ²) | 0.81 | | | |
| | lspta,a at zpii | (mW/cm ²) | 2.32 | | | |
| | pr to zpii | (MPa) | 2.59 | | | |
| b) The prr value reported correspond to the product of the frame rate and the number of lines per frame, which is the maximum number of pulses fired per second in all directions | | | | | | |











Table 12: Frequency 7,5MHz, Mode B-mode, 225V

| Index label | MI | TIS | | TIB | TIC | |
|--------------------------------|--|---------------------|---------------|------------|---------------|------|
| | | At surface | Below surface | At surface | Below surface | |
| Maximum index value | 0.72 | 0.22 | | 0.24 | | 0.24 |
| Index component value | | 0.22 | 0.22 | 0.24 | 0.22 | |
| Associated acoustic parameters | Pr,a at zMI (MPa) | 1.99 | | | | |
| | W0 (mW) | | 16.6 | | 16.6 | |
| | W1x1 (mW) | | 6.5 | | 6.5 | |
| | zs (cm) | | | 1.4 | | |
| | zb (cm) | | | | 1.84 | |
| | zMI (cm) | 1.85 | | | | |
| | zpii,a (cm) | 1.85 | | | | |
| | fawf (MHz) | 6.95 | 6.95 | | 6.95 | |
| Other information | pr (Hz) | 1280 ^(a) | | | | |
| | srr (Hz) | 10 | | | | |
| | npps | 1 | | | | |
| | lpa,a at zpii,a (W/cm ²) | 2070 | | | | |
| | lspta,a at zpii,a (mW/cm ²) | 0.77 | | | | |
| | lspta,a at zpii (mW/cm ²) | 1.93 | | | | |
| | pr at zpii (MPa) | 3.04 | | | | |
| | (a) The prr value reported correspond to the product of the frame rate and the number of lines per frame, which is the maximum number of pulses fired per second in all directions | | | | | |

11. Pictograms

Table 13 : Pictograms

| Pictogram | Reference | Name | Description |
|---|----------------------|--------------------------|---|
|  | ISO 7000 no. 3082 | Manufacturer | Indicates the medical device manufacturer, as defined in EU Directives 90/385/EEC, 93/42/EEC, and 98/79/EC. |
|  | ISO 7000 no. 2493 | Catalogue number | Indicates the manufacturer's catalogue number so that the medical device can be identified. |
|  | ISO 7000 no. 2498 | Serial number | Indicates the manufacturer's serial number so that a specific medical device can be identified. |
|  | ISO 15223 no. 5.7.10 | Unique Device Identifier | Indicates a carrier that contains Unique Device Identifier information. This symbol shall be placed adjacent to the Unique Device Identifier carrier. |
|  | ISO 7000 no. 2497 | Date of manufacture | Indicates the date when the medical device was manufactured. |
|  | ISO 7000 no. 0434A | Caution | Indicates the need for the User to consult the Instructions for Use for important cautionary information such as warnings and precautions that cannot, for a variety of reasons, be presented on the medical device itself. |

| | | | |
|---|---------------------|---|---|
|  | ISO 7000 no. 5031 | Direct current | To indicate on the rating plate that the equipment is suitable for direct current only and to identify relevant terminals. |
|  | ISO 7000 no. 5333 | Type BF applied part | To identify a type of BF applied part complying with IEC 60601-1. |
|  | ISO 7000 no. 6414 | WEEE; waste electrical and electronic equipment | To indicate that separate collection of waste electric and electronic equipment (WEEE) is required. |
|  | ISO 7010 no. M002 | Refer to instruction manual/booklet | To signify that the instruction manual / booklet must be read |
|  | ISO 15223 no.5.4.3 | Consult electronic instruction for use | Indicates the need for the User to consult the instructions for use online at www.echopen.com . |
|  | ISO 15223 no. 5.7.7 | Medical device | Indicates the item is a medical device. |
|  | EU 2017/745 | European conformity | Meets the requirements of the European Regulation for Medical Devices. |
|  | ASTM F2503-1 | MR Unsafe | Indicates an object that poses an unacceptable risk to the patient, medical personnel, or any other person present in the magnetic resonance environment. |
|  | ISO 15223 no.5.3.7 | Temperature limit | Indicates the temperature limits to which the medical device can be safely exposed. |
|  | ISO 15223 no.5.3.8 | Humidity limitation | Indicates the range of humidity to which the medical device can be safely exposed. |
|  | ISO 15223 no.5.3.9 | Atmospheric pressure limitation | Indicates the range of atmospheric pressure to which the medical device can be safely exposed. |